

LCDU375W & LCDU550W Dimensions

Wall Mount for Flat Panel Screens up to 21"

Model	Load Limit (lbs.)	Swivel	Tilt	Projection from Wall	Ship. Wt. (lbs.)
LCDU375W	20	180°	±45°	3-3/4"	5
LCDU550W	20	180°	±45°	5-1/2"	5

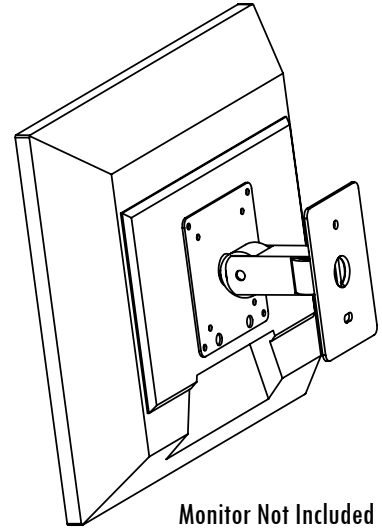

Monitor Not Included

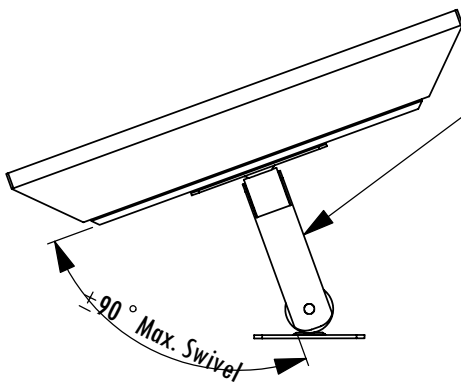

Shown with 20° Swivel.
Max. Swivel & Tilt restricted by monitor size

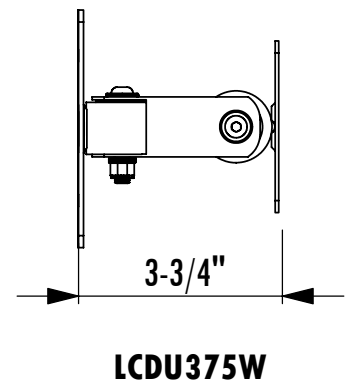
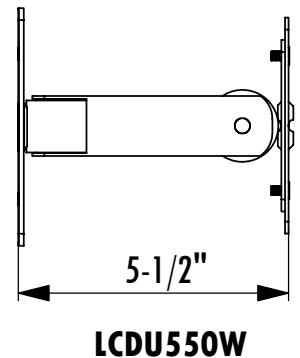
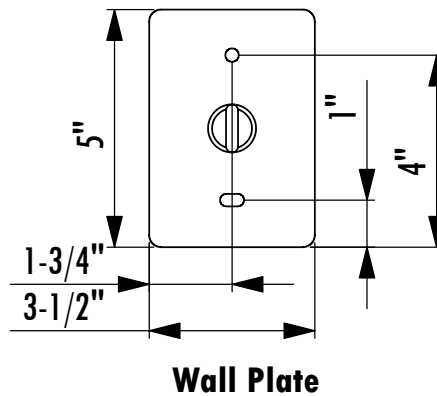
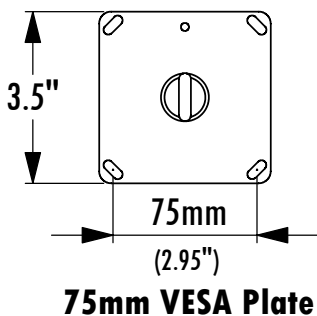
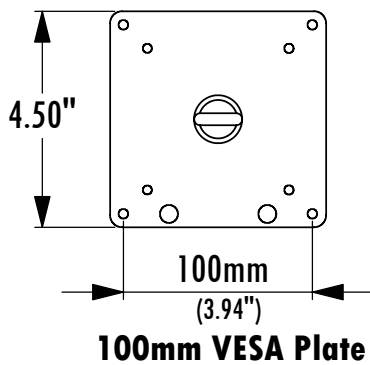
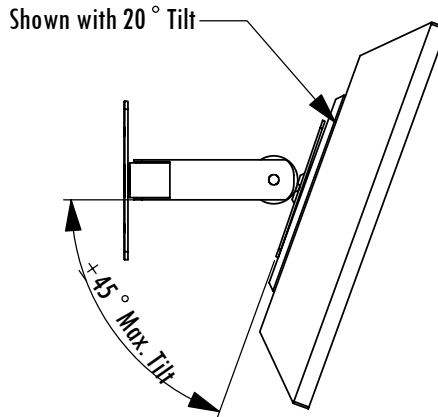

1-800-LUCASEY • 1-510-534-1435

©2005 Lucasey Manufacturing Corporation, Oakland, California

